



P91 / P91g Lead Acid Online UPS

1000VA, 2000VA, 3000VA Models

User & Installation Manual

Table of Contents

1. Important Safety Warning	1
1-1. Transportation.....	1
1-2. Preparation	1
1-3. Installation	1
1-4. Operation	2
1-5. Maintenance, service and faults.....	2
2. Installation and setup	4
2-1. Rear panel view.....	4
2-2. Operating principle	6
2-3. Install the UPS.....	6
2-4. Setup the UPS	7
2-5. Battery Replacement	11
2-6. Battery Kit Assembly.....	12
3. Operations	15
3-1. Button operation.....	15
3-2. LCD Panel	15
3-3. Audible Alarm	16
3-4. LCD display wordings index.....	17
3-5. UPS Setting.....	18
3-6. Operating Mode Description	22
3-7. Faults Reference Code	23
3-8. Warning indicator	23
4. Troubleshooting	24
5. Storage and Maintenance.....	25
6. Specifications	26
7. Obtaining Service	28
8. Xtreme Power Conversion Limited Warranty.....	29
9. Xtreme Power Conversion Load Protection Policy	31

1. Important Safety Warning

SAVE THESE INSTRUCTIONS - This manual contains important instructions that should be followed during installation and maintenance of the UPS and batteries.

Please comply with all warnings and operating instructions in this manual strictly. Do not operate this unit before reading through all safety information and operating instructions carefully.

1-1. Transportation

- ⓘ Please transport the UPS system only in the original package to protect against shock and impact.

1-2. Preparation

- ⓘ Condensation may occur if the UPS system is moved directly from cold to warm environment. The UPS system must be absolutely dry before being installed. Please allow at least two hours for the UPS system to acclimate to the environment.
- ⓘ Do not install the UPS system near water or in moist environments.
- ⓘ Do not install the UPS system where it would be exposed to direct sunlight or near heater.
- ⓘ Do not block ventilation holes in the UPS housing.

1-3. Installation

- ⓘ Do not connect appliances or devices which would overload the UPS system (e.g. laser printers) to the UPS output sockets.
- ⓘ Place cables in such a way that no one can step on or trip over them.
- ⓘ Do not connect domestic appliances such as hair dryers to UPS output sockets.
- ⓘ The UPS can be operated by any individuals with no previous experience.
- ⓘ Connect the UPS system only to an earthed shockproof outlet which must be easily accessible and close to the UPS system.
- ⓘ Please use only VDE-tested, CE-marked (for P91g models or UL-marked for P91 models) mains cable (e.g. the mains cable of your computer) to connect the UPS system to the building wiring outlet (shockproof outlet).
- ⓘ Please use only VDE-tested, CE-marked (for P91g models or UL-marked for P91 models) power cables to connect the loads to the UPS system.
- ⓘ When installing the equipment, it should ensure that the sum of the leakage current of the UPS and the connected devices does not exceed 3.5mA.
- ⓘ Temperature Rating - Units are considered acceptable for use in a maximum ambient of 40°C (104°F).
- ⓘ For Pluggable Equipment - The socket-outlet shall be installed near the equipment and shall be easily accessible.
- ⓘ CAUTION: The unit is heavy. Lifting the unit requires a minimum of two people.
- ⓘ Batteries with minimum case flame rating V-2 are intended for use in a computer room as defined in the Standard for the Protection of Information Technology Equipment, ANSI/NFAP 75. Batteries with case flame rating HB are not intended for use in a computer room. (US installations only.)

1-4. Operation

- ❓ Do not disconnect the mains cable on the UPS system or the building wiring outlet (shockproof socket outlet) during operations since this would cancel the protective earthing of the UPS system and of all connected loads.
- ❓ The UPS system features its own, internal current source (batteries). The UPS output sockets or output terminals block may be electrically live even if the UPS system is not connected to the building wiring outlet.
- ❓ In order to fully disconnect the UPS system, first press the OFF/Enter button to turn off the unit.
- ❓ Prevent fluids or other foreign objects from inside of the UPS system.
- ❓ The EPO and USB circuits are an IEC 60950-1 safety extra low voltage (SELV) circuit. This circuit must be separated from any hazardous voltage circuits by reinforced insulation.

1-5. Maintenance, service and faults

- ❓ The UPS system operates with hazardous voltages. Repairs may be carried out only by qualified maintenance personnel.
- ❓ **Caution** - risk of electric shock. Even after the unit is disconnected from the mains (building wiring outlet), components inside the UPS system are still connected to the battery and electrically live and dangerous.
- ❓ Before carrying out any kind of service and/or maintenance, disconnect the batteries and verify that no current is present and no hazardous voltage exists in the terminals of high capability capacitor such as BUS-capacitors.
- ❓ To avoid electrical shock, turn off the unit and unplug it from the AC power source before servicing the battery
- ❓ Only persons adequately familiar with batteries and with the required precautionary measures may replace batteries and supervise operations. Unauthorized persons must be kept well away from the batteries.
- ❓ **Caution** - risk of electric shock. The battery circuit is not isolated from the input voltage. Hazardous voltages may occur between the battery terminals and the ground. Before touching, please verify that no voltage is present!
- ❓ **Caution** - Do not dispose of batteries in a fire. The batteries may explode.
- ❓ **Caution** - Do not open or mutilate batteries. Released electrolyte is harmful to the skin and eyes. It may be toxic.
- ❓ A battery can may cause a risk of electrical shock and high short-circuit current. The following precautions should be observed when working on batteries:
 - a) Remove watches, rings, or other metal objects.
 - b) Use tools with insulated handles.
 - c) Wear rubber gloves and boots.
 - d) Do not lay tools or metal parts on top of batteries.
 - e) Disconnect charging source prior to connecting or disconnecting battery terminals.
 - f) Determine if battery is inadvertently grounded. If inadvertently grounded, remove source from ground. Contact with any part of a grounded battery can result in electrical shock. The likelihood of such shock can be reduced if such grounds are removed during installation and maintenance.

- ② When changing batteries, install the same number and same type of batteries or battery packs.
- ② Please replace the fuse only with the same type and amperage in order to avoid fire hazards.
- ② Do not dismantle the UPS system.
- ② **WARNING:** This is a category C2 UPS product. In a residential environment, this product may cause radio interference, in which case the user may be required to take additional measures. (only for CE models)
- ② **NOTE:** This equipment has been tested and found to comply with the limits for a Class A digital device, pursuant to part 15 of the FCC Rules. These limits are designed to provide reasonable protection against harmful interference when the equipment is operated in a commercial environment. This equipment generates, uses, and can radiate radio frequency energy and, if not installed and used in accordance with the instruction manual, may cause harmful interference to radio communications. Operation of this equipment in a residential area is likely to cause harmful interference in which case the user will be required to correct the interference at his own expense.
- ② **WARNING:** Changes or modifications not expressly approved by the party responsible for compliance could void the user's authority to operate the equipment.

2. Installation and setup

NOTE: Before installation, please inspect the unit. Be sure that nothing inside the package is damaged. Please keep the original package in a safe place for future use.

2-1. Rear panel view

P91g models:

1500 Model

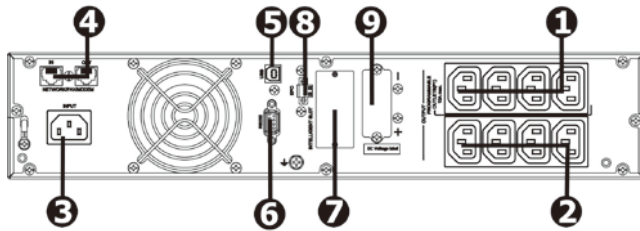

2000 Model

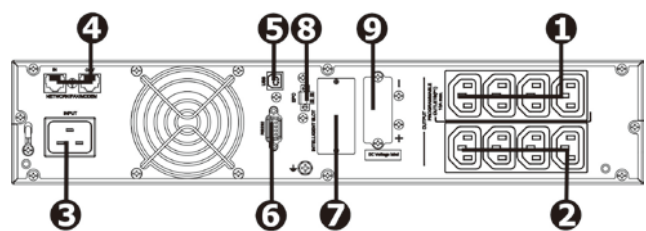

3000 Model

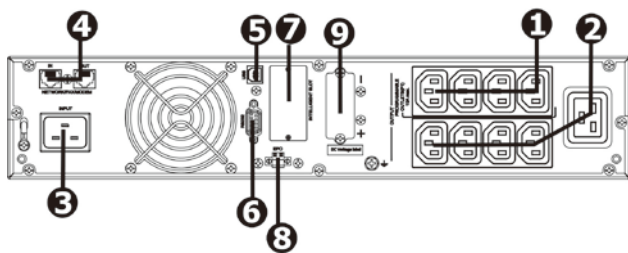

P91 models:

1000/1500 Model

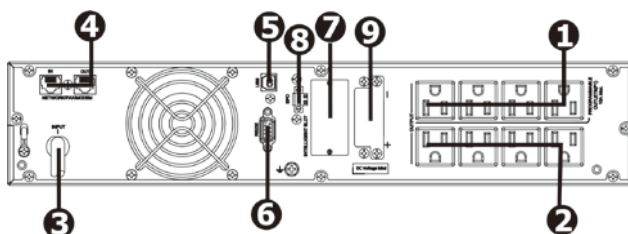

2000 Model

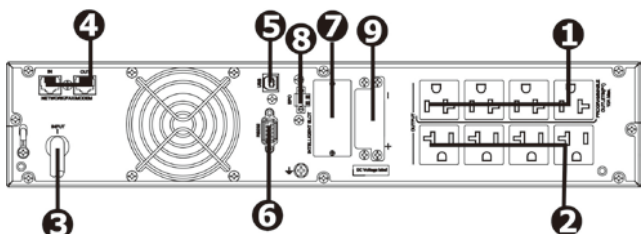

3000 Model

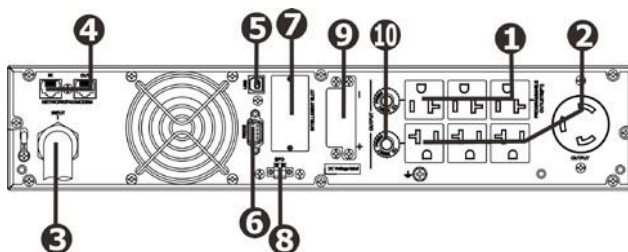

1. Programmable outlets: connect to non-critical loads.
2. Output receptacles: connect to mission-critical loads.
3. AC input
4. Network/Fax/Modem surge protection

5. USB communication port
6. RS-232 communication port
7. SNMP intelligent slot
8. Emergency power off function connector (EPO)
9. External battery connection
10. Output circuit breaker

2-2. Operating principle

The operating principle of the UPS is shown as below

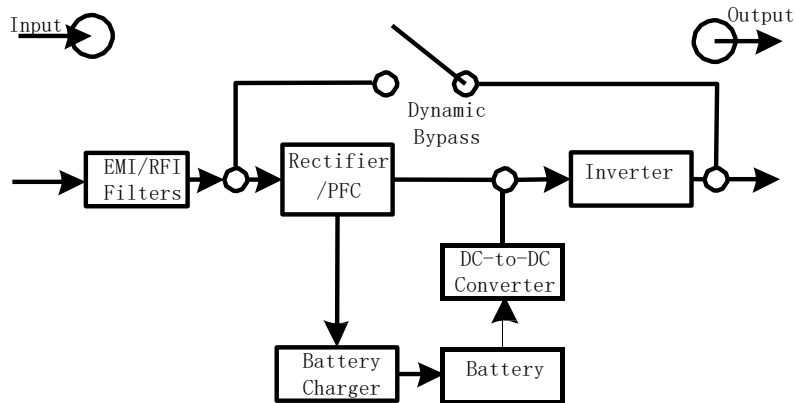

The UPS is composed of mains input, EMI/RFI filters, rectifier/PFC, inverter, battery charger, DC-to-DC converter, battery, dynamic bypass and UPS output.

2-3. Install the UPS

This UPS can be either displayed on the desk or mounted in the 19" rack chassis. Please choose proper installation to position this UPS.

Rack-mount Installation

Step 1

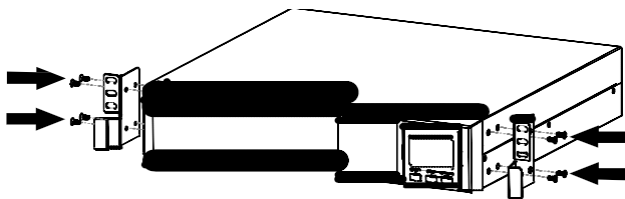

Step 2

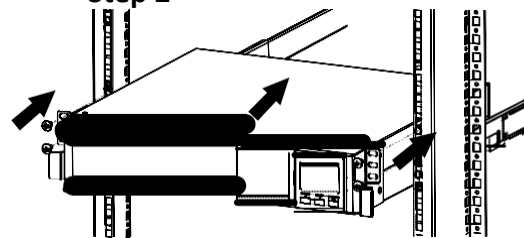

UPS Tower Installation

Step 1

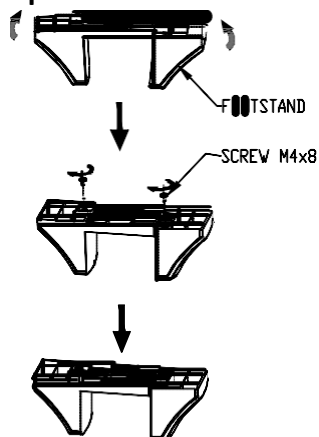

Step 2

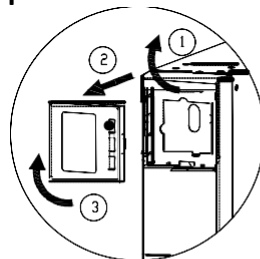

Step 3

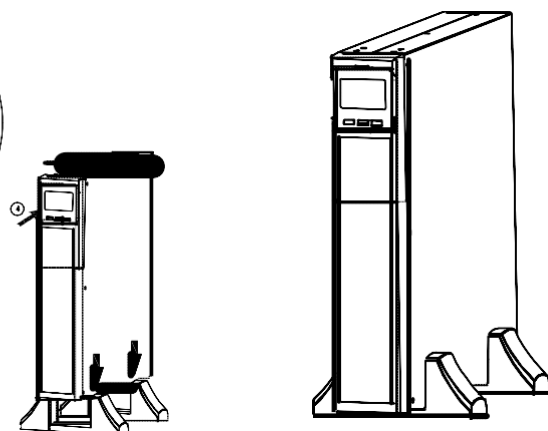

Tower Installation with battery pack

Step 1

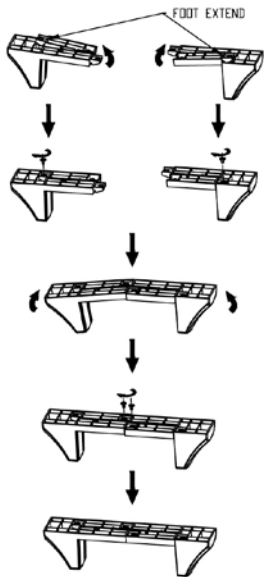

Step 2

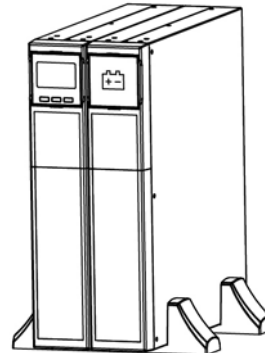

2-4. Setup the UPS

Before installing the UPS, please read below to select proper location to install UPS.

1. UPS should be placed on the flat and clean surface. Place it in an area away from vibration, dust, humidity, high temperature, flammable liquids, gas, corrosive and conductive contaminants. Install the UPS indoors in a clean environment, where it is away from window and door. Maintain minimum clearance of 100mm in the bottom of the UPS to avoid dust and high temperature.
2. Place UPS:
It's equipped with fan for cooling. Therefore, place the UPS in a well-ventilated area. It's required to maintain minimum clearance of 100mm in the front of the UPS and 300mm in the back and two sides of the UPS for heat dissipation and easy-maintenance.

Step 1: External battery connection

For safety consideration, the UPS is shipped out from factory without connecting battery wires.

Before connecting to external batteries, it's required to have the internal battery wire disconnected.

Follow the below steps to make external battery connection.

1. Turn off UPS and remove power plug from the mains.
2. Remove front panel and disconnect internal battery wire.

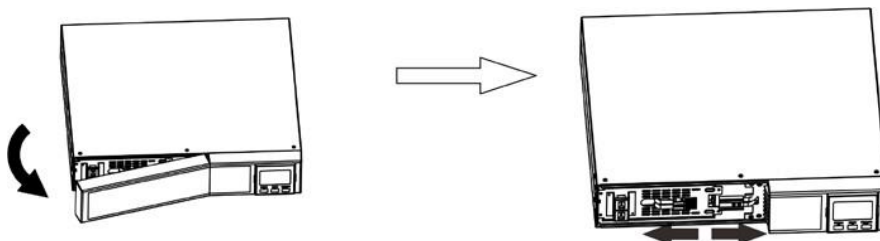

3. Remove the cover of the external battery connector by using a screwdriver.

4. Plug the battery cable into the external battery connector of the UPS and the battery pack(s).

Note: If you have multiple battery packs available, connect them serially. An example is shown in the diagram below (connecting the second battery connector of the first battery pack to the first battery connector of the second battery pack).

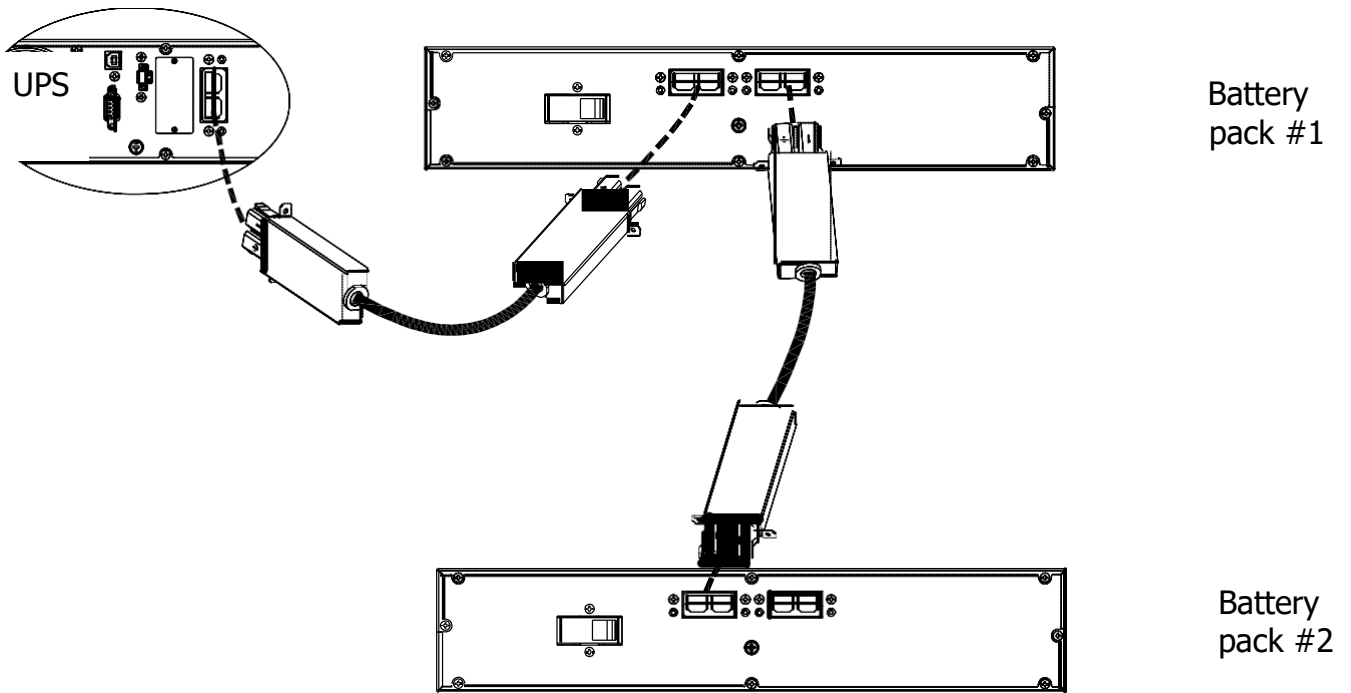
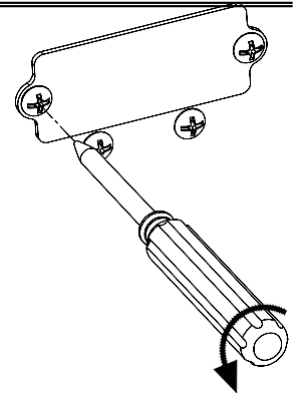

5. Stabilize the connector to the UPS and the battery pack(s) by fixing screws as shown below diagram.

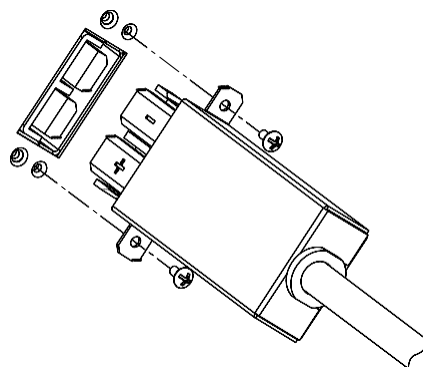

6. Connect internal battery connector and put the front panel back to the unit.

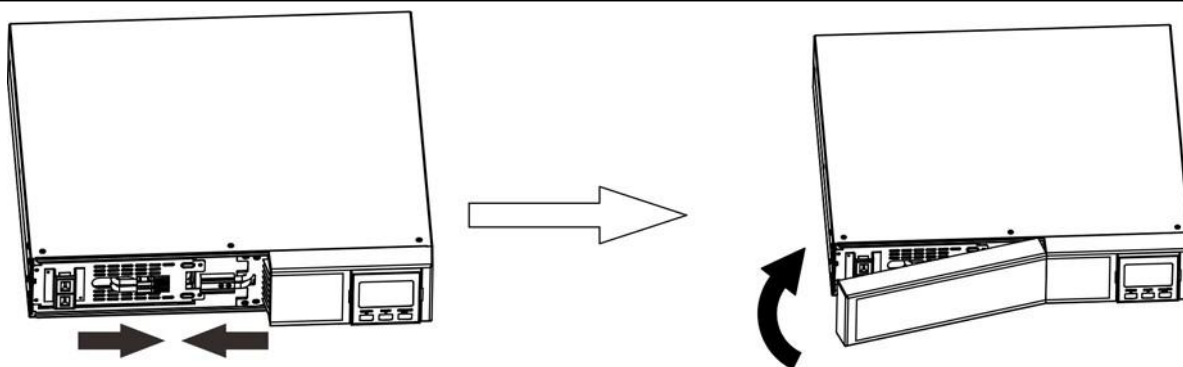

Step 2: UPS input connection

Plug the UPS into a two-pole, three-wire, grounded receptacle only. Avoid using extension cords.

- ☐ For P91g models: The power cord is supplied in the UPS package.
- ☐ For P91 models: The power cord is attached to the UPS. The input plug is a NEMA 5-15P for 1000 and 1500 models, NEMA 5-20P for 2000 model and NEMA L5-30P for 3000 model.

To reduce the risk of fire, connect only to a circuit provided with (@) a maximum branch circuit overcurrent protection in accordance with the National Electrical Code, ANSI/NFPA 70 and the Canadian Electrical Code, Part I, C22.1.

Model	(@)
P91-1000	20A
P91-1500	20A
P91-2000	20A
P91-3000	40A

Step 3: UPS output connection

There are two kinds of outputs: programmable outlets and general outlets. Please connect non-critical devices to the programmable outlets and critical devices to the general outlets. During power failure, you may extend the backup time to critical devices by setting shorter backup time for non-critical devices.

Step 4: Communication connection

Communication port:

USB port



RS-232 port

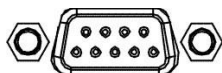

Intelligent slot



To allow for unattended UPS shutdown/start-up and status monitoring, connect the communication cable one end to the USB/RS-232 port and the other to the communication port of your PC. With the monitoring software installed, you can schedule UPS shutdown/start-up and monitor UPS status through PC.

The UPS is equipped with intelligent slot perfect for either SNMP or AS400 card. When installing either SNMP or AS400 card in the UPS, it will provide advanced communication and monitoring options.

Step 5: Network connection

Network/Fax/Phone surge port



Connect a single modem/phone/fax line into surge-protected "IN" outlet on the back panel of the UPS unit. Connect from "OUT" outlet to the equipment with another modem/fax/phone line cable.

Step 6: Disable and enable EPO function

This UPS is equipped with EPO function. By default, the UPS is delivered from factory with Pin 1 and pin 2 closed (a metal plate is connected to Pin 1 and Pin2) for UPS normal operation. To activate EPO function, remove two screws on EPO port and metal plate will be removed.

Note: The EPO function logic can be set up via LCD setting. Please refer to program 16 in UPS setting for the details.

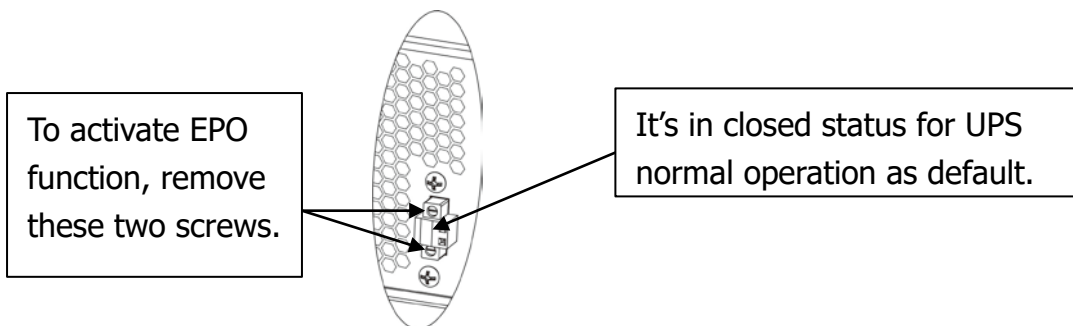

Step 7: Turn on the UPS

Press the ON/Mute button on the front panel for two seconds to power on the UPS.



Note: The battery charges fully during the first five hours of normal operation. Do not expect full battery run capability during this initial charge period.

Step 8: Install software

For optimal computer system protection, install UPS monitoring software to fully configure UPS shutdown. Use supplied RS-232 or USB communication cable to connect RS-232/USB port of UPS and RS-232/USB port of PC. Then, follow below steps to install monitoring software.

1. Insert the included installation CD into CD-ROM drive and then follow the on-screen instructions to proceed software installation. If there no screen shows 1 minute after inserting the CD, please execute setup.exe file for initiating software installation.
2. Follow the on-screen instructions to install the software.
3. When your computer restarts, the monitoring software will appear as an orange plug icon located in the system tray, near the clock.

2-5. Battery Replacement

When the icons of  and  are flashing in LCD display and alarm is sounding every 2 seconds, it's time to replace batteries. Contact your service representative to replace batteries.

Do not disconnect battery connectors under load. If you prefer to remove input power to change the batteries, press the OFF button on the front panel for two seconds to power off the UPS and switch off utility power where the UPS is connected.

NOTE 1: DO NOT DISCONNECT the batteries while the UPS is in Battery mode.

NOTE 2: A small amount of arcing may occur when connecting the internal batteries. This is normal condition and no harm for personnel. Connect the cables quickly and firmly.

NOTE 3: This UPS is equipped with internal batteries and only service person can replace the batteries.

NOTE 4: Upon battery disconnection, equipment is not protected from power outages.

CAUTION!! Consider all warnings, cautions, and notes before replacing batteries.

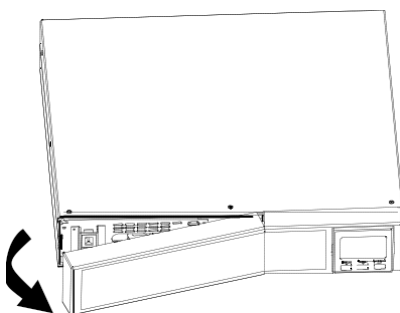
Step 1

Remove front panel.

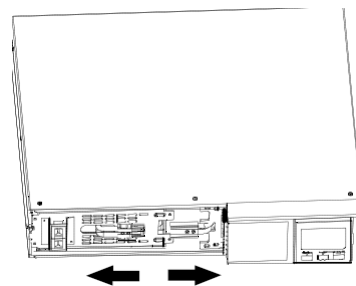
Step 2

Disconnect battery wires.

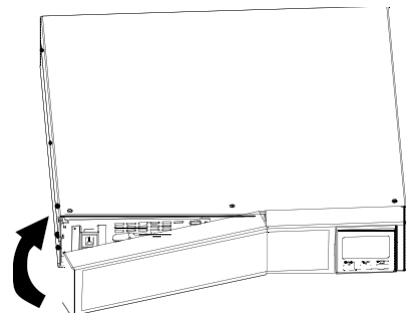
Step 3

Pull out the battery box by removing two screws on the front panel.

Step 4

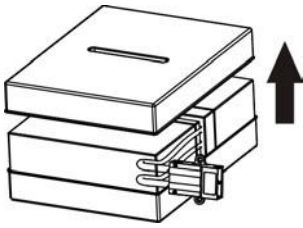

Remove the top cover of battery box and replace the inside batteries.

Step 5

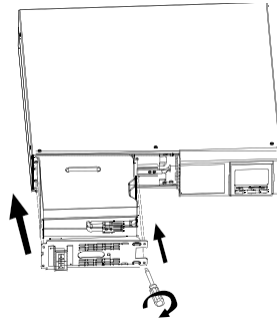

After replacing the batteries, put the battery box back to original location and screw it tightly.

Step 6

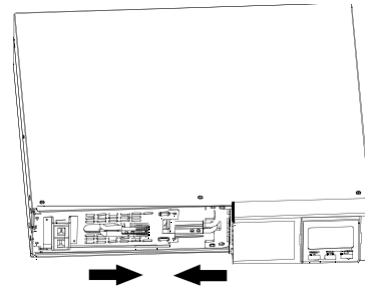

Re-connect the battery wires.

Step 7

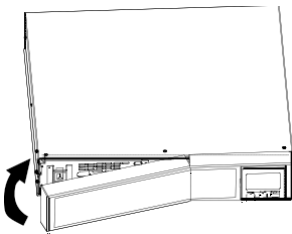

Put the front panel back to the unit.

2-6. Battery Kit Assembly

NOTICE: Please assemble battery kit first before installing it inside of UPS. Please select correct battery kit procedure below to assemble it.

2-battery kit

Step 1: Remove adhesive tapes.

Tapes

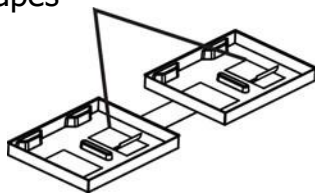

Step 3: Put assembled battery packs on one side of plastic shells.

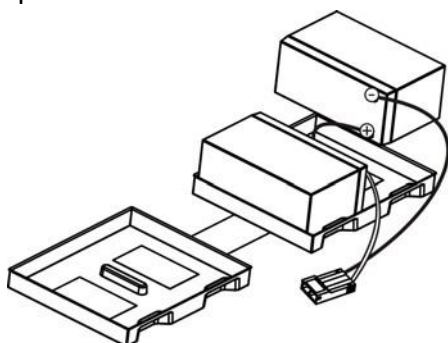

Step 2: Connect all battery terminals by following below chart.

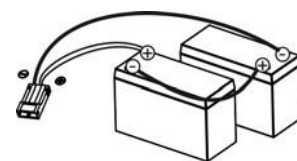

Step 4: Cover the other side of plastic shell as below chart. Then, battery kit is assembly well.

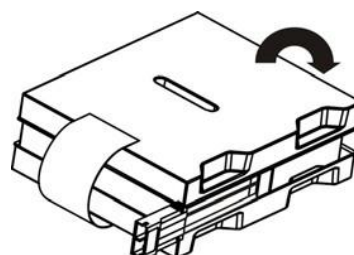

3-battery kit

Step 1: Remove adhesive tapes.

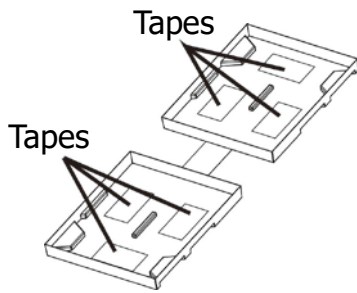

Step 2: Connect all battery terminals by following below chart.

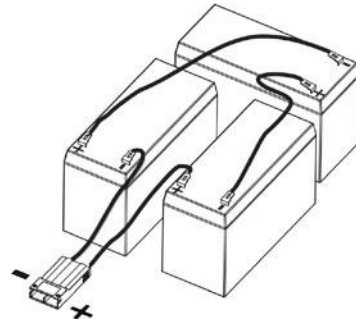

Step 3: Put assembled battery packs on one side of plastic shells as below chart.

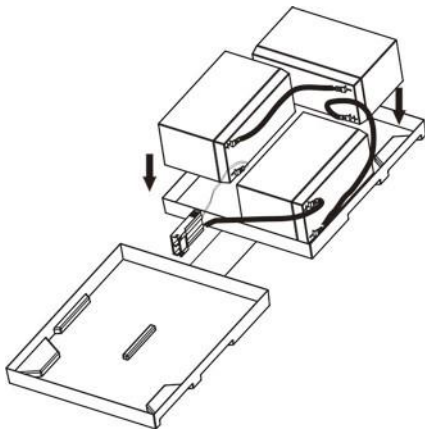

Step 4: Cover the other side of plastic shell as below chart. Then, battery kit is assembly well.

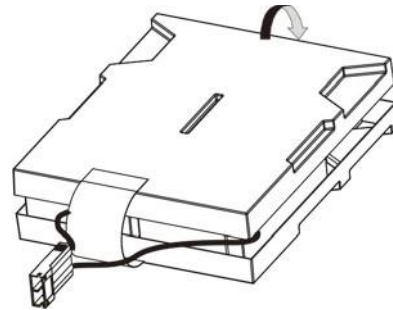

4-battery kit

Step 1: Remove adhesive tapes.

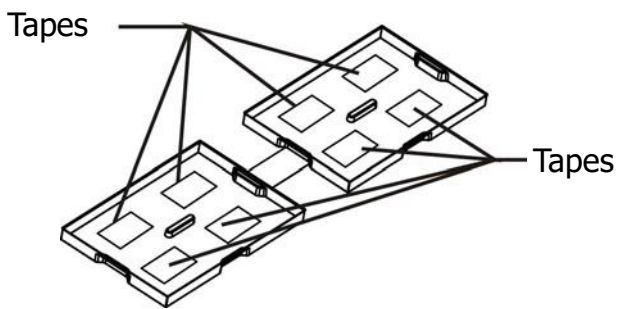

Step 2: Connect all battery terminals by following below chart.

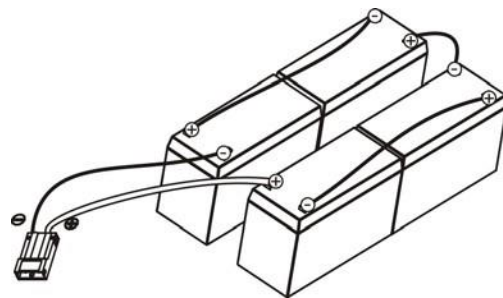

Step 3: Put assembled battery packs on one side of plastic shells.

Step 4: Cover the other side of plastic shell as below chart. Then, battery kit is assembly well.

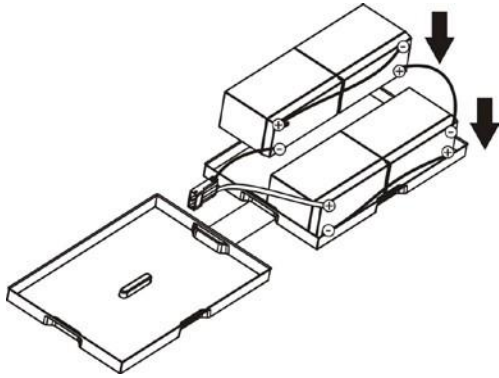

6-battery kit

Step 1: Remove adhesive tapes.

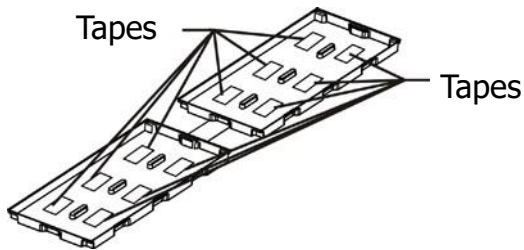

Step 3: Put assembled battery packs on one side of plastic shells.

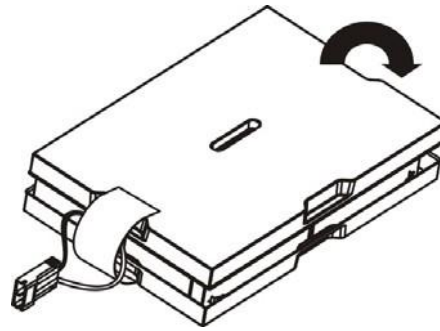
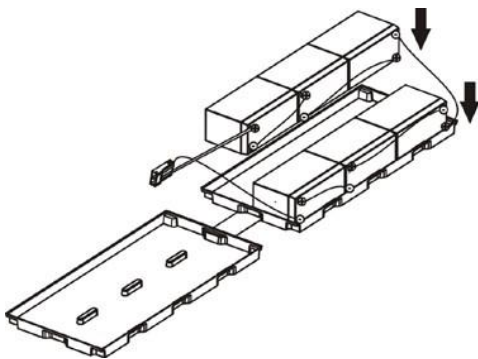

Step 2: Connect all battery terminals by following below chart.

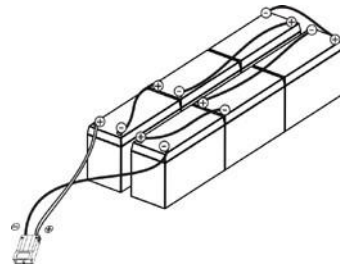

Step 4: Cover the other side of plastic shell as below chart. Then, battery kit is assembly well.

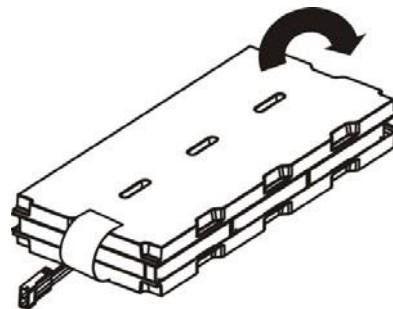

3. Operations







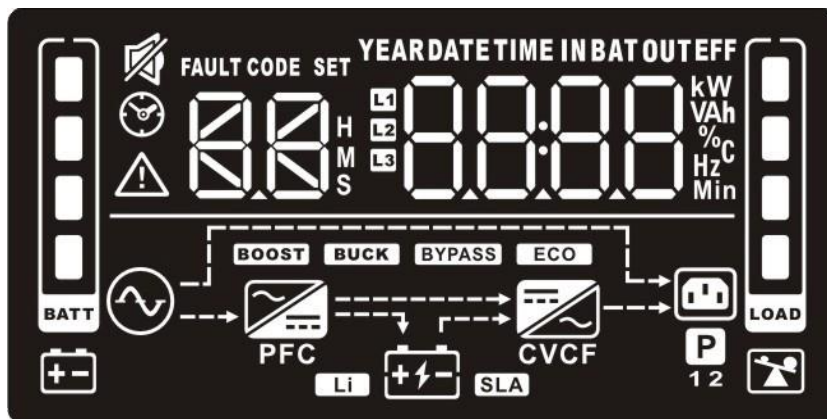





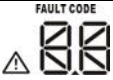







3-1. Button operation

Button	Function
ON/Mute Button	<ul style="list-style-type: none"> ☐ Turn on the UPS: Press and hold ON/Mute button for at least 2 seconds to turn on the UPS. ☐ Mute the alarm: After the UPS is turned on in battery mode, press and hold this button for at least 3 seconds to disable or enable the alarm system. But it’s not applied to the situations when warnings or errors occur. ☐ Up key: Press this button to display previous selection in UPS setting mode. ☐ Switch to UPS self-test mode: Press ON/Mute buttons for 3 seconds to enter UPS self-testing while in AC mode, ECO mode, or converter mode.
OFF/Enter Button	<ul style="list-style-type: none"> ☐ Turn off the UPS: Press and hold this button at least 2 seconds to turn off the UPS. UPS will be in standby mode under power normal or transfer to Bypass mode if the Bypass enable setting is set by pressing this button. ☐ Confirm selection key: Press this button to confirm selection in UPS setting mode.
Select Button	<ul style="list-style-type: none"> ☐ Switch LCD message: Press this button to change the LCD message for input voltage, input frequency, input current, battery voltage, battery current, battery capacity, ambient temperature, output voltage, output frequency, load current and load percent. ☐ Setting mode: Press and hold this button for 3 seconds to enter UPS setting mode when Standby and Bypass mode. ☐ Down key: Press this button to display next selection in UPS setting mode.
ON/Mute + Select Button	<ul style="list-style-type: none"> ☐ Switch to bypass mode: When the main power is normal, press ON/Mute and Select buttons simultaneously for 3 seconds. Then UPS will enter to bypass mode. This action will be ineffective when the input voltage is out of acceptable range. ☐ Exit setting mode or return to the upper menu: When working in setting mode, press ON/Mute and Select buttons simultaneously for 0.2 seconds to return to the upper menu. If it’s already in top menu, press these two buttons at the same time to exit the setting mode.

3-2. LCD Panel



Display	Function
Backup time information	

	Indicates the estimated backup time. H: hours, M: minute, S: second.
Configuration and fault information	
	Indicates the configuration items, and the configuration items are listed in details in section 3-5.
	Indicates the warning and fault codes, and the codes are listed in details in section 3-7 and 3-8.
Mute operation	
	Indicates that the UPS alarm is disabled.
Input, Battery, Temperature, Output & Load information	
	Indicate the input voltage, input frequency, input current, battery voltage, battery current, battery capacity, ambient temperature, output voltage, output frequency, load current and load percent. k: kilo, W: watt, V: voltage, A: ampere, %: percent, °C: centigrade degree, Hz: frequency
Load information	
	Indicates the load level by 0-24%, 25-49%, 50-74% and 75-100%.
	Indicates overload.
Programmable outlets information	
	Indicates that programmable management outlets are working.
Mode operation information	
	Indicates the UPS connects to the mains.
	Indicates the battery is working.
	Indicates charging status
	Indicates the bypass circuit is working.
	Indicates the ECO mode is enabled.
	Indicates the AC to DC circuit is working.
	Indicates the PFC circuit is working.
	Indicates the inverter circuit is working.
	Indicates the UPS is working in converter mode.
	Indicates the output is working.
Battery information	
	Indicates the battery level by 0-24%, 25-49%, 50-74%, and 75-100%.
	Indicates low battery.

3-3. Audible Alarm

Battery Mode	Sounding every 5 seconds
--------------	--------------------------

Low Battery	Sounding every 2 seconds
Overload	Sounding every second
Fault	Continuously sounding
Bypass Mode	Sounding every 10 seconds

3-4. LCD display wordings index

Abbreviation	Display content	Meaning
ENA	ENR	Enable
DIS	di S	Disable
ESC	ESC	Escape
HLS	HLS	High loss
LLS	LLS	Low loss
AO	AO	Active open
AC	AC	Active close
EAT	EAt	Estimated autonomy time
RAT	rAt	Running autonomy time
SD	Sd	Shutdown
OK	OK	OK
ON	ON	ON
BL	bL	Battery Low
OL	OL	Over Load
OI	OI	Over input current
NC	nC	Battery No Connect
OC	OC	Over Charge
SF	SF	Site wiring fault
EP	EP	EPO
TP	tP	Temperature
CH	CH	Charger
BF	bF	Battery Fault
BV	bV	Bypass Out Range
FU	FU	Bypass frequency unstable
BR	bR	Battery Replace
EE	EE	EEPROM error

3-5. UPS Setting

There are three parameters to set up the UPS.
 Parameter 1: It’s for program alternatives. Refer to below table.

Parameter 2 is the setting options or values for each program.

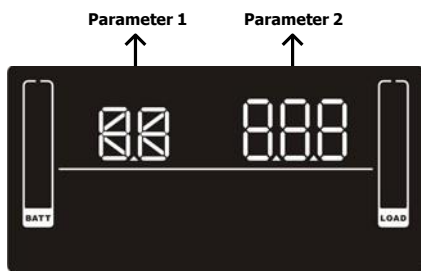

• 01: Output voltage setting

Interface	Setting
	<p>Parameter 2: Output voltage For P91g models, you may choose the following output voltage: 200: presents output voltage is 200Vac 208: presents output voltage is 208Vac 220: presents output voltage is 220Vac 230: presents output voltage is 230Vac (Default) 240: presents output voltage is 240Vac For P91 models, you may choose the following output voltage: 100: presents output voltage is 100Vac 110: presents output voltage is 110Vac 115: presents output voltage is 115Vac 120: presents output voltage is 120Vac (Default) 125: presents output voltage is 125Vac</p>

• 02: Frequency Converter enable/disable

Interface	Setting
	<p>Parameter 2: Enable or disable converter mode. You may choose the following two options: CF ENA: converter mode enable CF DIS: converter mode disable (Default)</p>



• 03: Output frequency setting

Interface	Setting
	<p>Parameter 2: Output frequency setting. You may set the initial frequency on battery mode: BAT 50: presents output frequency is 50Hz BAT 60: presents output frequency is 60Hz If converter mode is enabled, you may choose the following output frequency: CF 50: presents output frequency is 50Hz CF 60: presents output frequency is 60Hz</p>

• **04: ECO enable/disable**

Interface	Setting
	<p>Parameter 2: Enable or disable ECO function. You may choose the following two options: ENA: ECO mode enable DIS: ECO mode disable (Default)</p>



• **05: ECO voltage range setting**

Interface	Setting
 	<p>Parameter 2: Set the acceptable high voltage point and low voltage point for ECO mode by pressing Down key or Up key. HLS: High loss voltage in ECO mode in parameter 2. For P91g models, the setting range in parameter 3 is from +7V to +24V of the nominal voltage. (Default: +12V) For P91 models, the setting range in parameter 3 is from +3V to +12V of the nominal voltage. (Default: +6V) LLS: Low loss voltage in ECO mode in parameter 2. For P91g models, the setting range in parameter 3 is from -7V to -24V of the nominal voltage. (Default: -12V) For P91 models, the setting voltage in parameter 3 is from -3V to -12V of the nominal voltage. (Default: -6V)</p>

• **06: Bypass enable/disable when UPS is off**

Interface	Setting
	<p>Parameter 2: Enable or disable Bypass function. You may choose the following two options: ENA: Bypass enable DIS: Bypass disable (Default)</p>

• **07: Bypass voltage range setting**

Interface	Setting
 	<p>Parameter 2: Set the acceptable high voltage point and acceptable low voltage point for Bypass mode by pressing the Down key or Up key. HLS: Bypass high voltage point For P91g models: 230-264: setting the high voltage point from 230Vac to 264Vac. (Default: 264Vac) For P91 models: 120-140: setting the high voltage point from 120Vac to 140Vac. (Default: 132Vac) LLS: Bypass low voltage point For P91g models 170-220: setting the low voltage point from 170Vac to 220Vac. (Default: 170Vac) For P91 models: 85-115: setting the low voltage point from 85Vac to 115Vac.</p>

	(Default: 85Vac)
--	------------------

• **08: Bypass frequency range setting**

Interface	Setting
	<p>Parameter 2: Set the acceptable high frequency point and acceptable low frequency point for Bypass mode by pressing the Down key or Up key.</p> <p>HLS: Bypass high frequency point For 50Hz output frequency models: 51-55Hz: setting the frequency high loss point from 51Hz to 55Hz. (Default: 53.0Hz) For 60Hz output frequency models: 61-65Hz: setting the frequency high loss point from 61Hz to 65Hz. (Default: 63.0Hz)</p>
	<p>LLS: Bypass low Frequency point For 50Hz output frequency models: 45-49Hz: setting the frequency low loss point from 45Hz to 49Hz. (Default: 47.0Hz) For 60Hz output frequency models: 55-59Hz: setting the frequency low loss point from 55Hz to 59Hz. (Default: 57.0Hz)</p>

• **09: Programmable outlets enable/disable**

Interface	Setting
	<p>Parameter 2: Enable or disable programmable outlets.</p> <p>ENA: Programmable outlets enable DIS: Programmable outlets disable (Default)</p>

• **10: Programmable outlets setting**

Interface	Setting
	<p>Parameter 2: Set up backup time limits for programmable outlets.</p> <p>0-999: setting the backup time limits in minutes from 0-999 for programmable outlets which connect to non-critical devices on battery mode. (Default: 999)</p>

• **11: Autonomy limitation setting**

Interface	Setting
	<p>Parameter 2: Set up backup time on battery mode for general outlets.</p> <p>0-999: setting the backup time in minutes from 0-999 for general outlets on battery mode.</p> <p>DIS: Disable the autonomy limitation and the backup time will depend on battery capacity. (Default)</p> <p>Note: When setting as “0”, the backup time will be only 10 seconds.</p>

• **12: Battery total AH setting**

Interface	Setting

	<p>Parameter 2: Set up the battery total AH of the UPS. 7-999: setting the battery total capacity from 7-999 in AH. Please set the correct battery total capacity if external battery bank is connected.</p>
---	--

• **13: Maximum charger current setting**

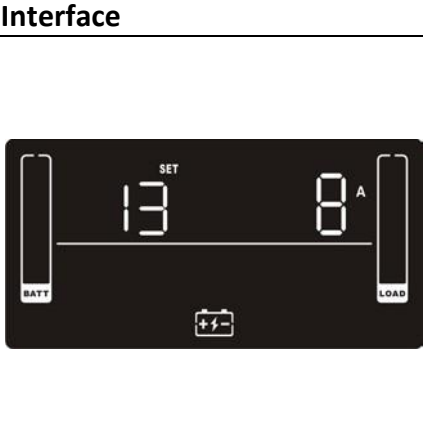
	<p>Parameter 2: Set up the charger maximum current. 1/2/4/6/8: setting the charger maximum current 1/2/4/6/8 in Ampere. (Default: 2A) Note: Please set the appropriate charger current based on battery capacity used. The recommended charging current is 0.1C~0.3C of battery capacity as following table for reference.</p> <table border="1" data-bbox="608 698 1318 866"> <thead> <tr> <th>Battery capacity(AH)</th> <th>Total charging current (A)</th> </tr> </thead> <tbody> <tr> <td>7~20</td> <td>2</td> </tr> <tr> <td>20~40</td> <td>4</td> </tr> <tr> <td>40~60</td> <td>6</td> </tr> <tr> <td>60~</td> <td>8</td> </tr> </tbody> </table>	Battery capacity(AH)	Total charging current (A)	7~20	2	20~40	4	40~60	6	60~	8
Battery capacity(AH)	Total charging current (A)										
7~20	2										
20~40	4										
40~60	6										
60~	8										

• **14: Charger boost voltage setting**

	<p>Parameter 2: Set up the charger boost voltage. 2.25-2.40: setting the charger boost voltage from 2.25 V/cell to 2.40V/cell. (Default: 2.36V/cell)</p>
--	---

• **15: Charger float voltage setting**

	<p>Parameter 2: Set up the charger float voltage. 2.20-2.33: setting the charger float voltage from 2.20 V/cell to 2.33V/cell. (Default: 2.28V/cell)</p>
---	---

• **16: EPO logic setting**

	<p>Parameter 2: Set up the EPO function control logic. AO: Active Open (Default). When AO is selected as EPO logic, it will activate EPO function with Pin 1 and Pin 2 in open status. AC: Active Close. When AC is selected as EPO logic, it will activate EPO function with Pin 1 and Pin 2 in close status.</p>
---	---

• **17: Site fault detection enable/disable**

Interface	Setting
	<p>Parameter 2: Enable or disable site fault detection. You may choose the following two options:</p> <p>ENA: Site fault detection enable (Default for P91 models)</p> <p>DIS: Site fault detection disable (Default for P91g models)</p>





• **18: Display setting for autonomy time**

Interface	Setting
	<p>Parameter 2: Set up the display setting for autonomy time</p> <p>EAT: If EAT is selected, it will display the remaining autonomy time. (Default)</p> <p>RAT: If RAT is selected, it will show accumulated autonomy time so far.</p>

• **00: Exit setting**

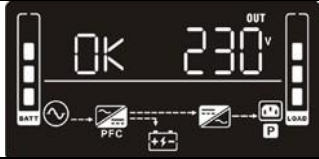
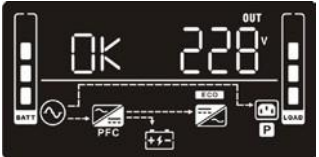
Interface	Setting
	<p>Exit the setting mode.</p>

3-6. Operating Mode Description



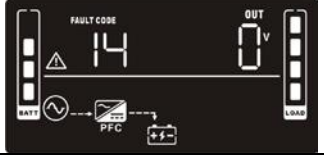











Operating mode	Description	LCD display
Online mode	When the input voltage is within acceptable range, UPS will provide pure and stable AC power to output. The UPS will also charge the battery in online mode.	
ECO mode	Energy saving mode: When the input voltage is within voltage regulation range, UPS will bypass voltage to output for energy saving. The UPS will also charge the battery at ECO mode.	
Frequency Converter mode	When input frequency is within 40 Hz to 70 Hz, the UPS can be set at a constant output frequency, 50 Hz or 60 Hz. The UPS will still charge battery under this mode.	
Battery mode	When the input voltage is beyond the acceptable range or power failure, the UPS will backup power from battery and alarm is sounding every 5 seconds.	
Bypass mode	When input voltage is within acceptable range but UPS is overload, UPS will enter bypass mode or bypass mode can be set by front panel. Alarm is sounding every 10 seconds.	

Standby mode	UPS is powered off and no output supply power, but still can charge batteries.	
Fault mode	When a fault has occurred, the ERROR icon and the fault code will be displayed.	

3-7. Faults Reference Code

Fault event	Fault code	Icon	Fault event	Fault code	Icon
Bus start fail	01	x	Battery voltage too high	27	x
Bus over	02	x	Battery voltage too low	28	x
Bus under	03	x	Charger output short	2A	x
Inverter soft start fail	11	x	Over temperature	41	x
Inverter voltage high	12	x	Overload	43	
Inverter voltage Low	13	x	Charger failure	45	x
Inverter output short	14	x	Over input current	49	x













3-8. Warning indicator

Warning	Icon (flashing)	Code	Alarm
Low Battery		bL	Sounding every 2 seconds
Overload		OL	Sounding every second
Over input current		OI	Sounding 2 beep every 10 seconds
Battery is not connected		NC	Sounding every 2 seconds
Over Charge		OC	Sounding every 2 seconds
Site wiring fault		SF	Sounding every 2 seconds
EPO enable		EP	Sounding every 2 seconds
Over temperature		TP	Sounding every 2 seconds
Charger failure		CH	Sounding every 2 seconds
Battery fault		bF	Sounding every 2 seconds (At this time, UPS is off to remind users something wrong with battery)
Out of bypass voltage range		bV	Sounding every 2 seconds
Bypass frequency unstable		FU	Sounding every 2 seconds
Battery replacement		bT	Sounding every 2 seconds
EEPROM error		EE	Sounding every 2 seconds

NOTE: “Site Wiring Fault” function can be enabled/disabled via software. Please check software manual for the details.

4. Troubleshooting

If the UPS system does not operate correctly, please solve the problem by using the table below.

Symptom	Possible cause	Remedy
No indication and alarm even though the mains is normal.	The AC input power is not connected well.	Check if input power cord firmly connected to the mains.
	The AC input is connected to the UPS output.	Plug AC input power cord to AC input correctly.
The icon  and the warning code  flash on LCD display and alarm is sounding every 2 seconds.	EPO function is activated.	Set the circuit in closed position to disable EPO function.
The icons of  and  , and the warning code  flash on LCD display. Alarm is sounding every 2 seconds.	Line and neutral conductors of UPS input are reversed.	Rotate mains power socket by 180° and then connect to UPS system.
The icons of  and  and the warning code  flash on LCD display. Alarm is sounding every 2 seconds.	The external or internal battery is incorrectly connected.	Check if all batteries are connected well.
Fault code is shown as 27 on LCD display and alarm is continuously sounding.	Battery voltage is too high or the charger is fault.	Contact your dealer.
Fault code is shown as 28 on LCD display and alarm is continuously sounding.	Battery voltage is too low or the charger is fault.	Contact your dealer.
The icons  and  and the warning code  flash on LCD display. Alarm is sounding every second.	UPS is overload	Remove excess loads from UPS output.
	UPS is overloaded. Devices connected to the UPS are fed directly by the electrical network via the Bypass.	Remove excess loads from UPS output.
	After repetitive overloads, the UPS is locked in the Bypass mode. Connected devices are fed directly by the mains.	Remove excess loads from UPS output first. Then shut down the UPS and restart it.
Fault code is shown as 49 on LCD display and alarm is continuously sounding.	UPS is over input current.	Remove excess loads from UPS output.
Fault code is shown as 43 and the icon  is lighting on LCD display. Alarm is continuously sounding.	The UPS shut down automatically because of overload at the UPS output.	Remove excess loads from UPS output and restart it.

Symptom	Possible cause	Remedy
Fault code is shown as 14 on LCD display and alarm is continuously sounding.	The UPS shut down automatically because short circuit occurs on the UPS output.	Check output wiring and if connected devices are in short circuit status.
Fault code is shown as 01, 02, 03, 11, 12, 13 and 41 on LCD display and alarm is continuously sounding.	A UPS internal fault has occurred. There are two possible results: 1. The load is still supplied, but directly from AC power via bypass. 2. The load is no longer supplied by power.	Contact your dealer
Battery backup time is shorter than nominal value.	Batteries are not fully charged	Charge the batteries for at least 5 hours and then check capacity. If the problem still persists, consult your dealer.
	Batteries defect	Contact your dealer to replace the battery.
Fault code is shown as 2A on LCD display and alarm is continuously sounding.	The short circuit occurs on the charger output.	Check if battery wiring of connected external pack is in short circuit status.
Fault code is shown as 45 on LCD display. At the same time, alarm is continuously sounding.	The charger does not have output and battery voltage is less than 10V/PC.	Contact your dealer.

5. Storage and Maintenance

Operation

The UPS system contains no user-serviceable parts. If the battery service life (3~5 years at 25°C ambient temperature) has been exceeded, the batteries must be replaced. In this case, please contact your dealer.



Be sure to deliver the spent battery to a recycling facility or ship it to your dealer in the replacement battery packing material.

Storage

Before storing, charge the UPS 5 hours. Store the UPS covered and upright in a cool, dry location. During storage, recharge the battery in accordance with the following table:

Storage Temperature	Recharge Frequency	Charging Duration
-25°C - 40°C	Every 3 months	1-2 hours
40°C - 45°C	Every 2 months	1-2 hours

6. Specifications

P91 models:

MODEL	P91-1000	P91-1500	P91-2000	P91-3000
CAPACITY	1000VA (1000W)	1500VA (1450W)	2000VA (1930W)	3000VA (2880W)
INPUT	55–150VAC* / 50/60Hz auto-sensing			
OUTPUT	Voltage	100**/110/115/120/125 Vac selectable		
	Waveform	Pure sine wave: <=2% THD (linear load), <=4% THD (non-linear load)		
	Frequency	50/60Hz +/-0.1Hz		
	Efficiency	Up to 98%		
	Overload capacity	> 110% & ≤ 130% for 5 min; > 130% & ≤140% for 30 sec; >140% for 1.5 sec		
BATTERY	Battery chemistry	Sealed, maintenance-free lead acid		
	Battery size	(2) 12V 9AH	(3) 12V 9AH	(4) 12V 9AH
	Typical recharge / charger	< 3 hours to 95% with 2A charger current		
	Charger current	2A default, Max 8A Adjustable		
PHYSICAL	Charger voltage	27.4VDC	41.1VDC	54.8VDC
	Dimensions (W x D x H, in)	17.2 x 15.1 x 3.5***		17.2 x 19 x 3.5***
	Weight (lbs)	25.6	34.2	43
	Line cord	6 ft, 5–15P		6 ft, 5–20P
ENVIRONMENT	Receptacles	(8) NEMA 5–15R		(8) NEMA 5–15/20R
	Temperature	32–104°F (0 ~ 40°C)		
	Altitude	11,500 ft above sea level		
APPROVALS	UL, cUL, RoHS, FCC Class B (1000, 1500VA), FCC Class A (2000, 3000VA)			
WARRANTY	3 years electronics, 3 years battery warranty (USA and Canada)			
COMMUNICATION INTERFACE	RS-232 (2U), USB, EPO, intelligent slot for optional cards (Web/SNMP, Relay/dry contact, Modbus)			
INCLUDED IN BOX	ViewPower software, horizontal brackets, tower pedestals, user manual			
AVAILABLE OPTIONS	Bypass distribution (XBDM), power distribution (XPDU), 4-post rail kit, 2-post shelf kit, wall mount bracket			

*Depending on load level

P91g models:

MODEL	P91g-1500	P91g-2000	P91g-3000
CAPACITY	1500VA (1500W)	2000VA (2000W)	3000VA (3000W)
INPUT	110-300 VAC* / 50/60Hz auto-sensing		
OUTPUT	Voltage	200**/208**/220/230/240 Vac selectable	
	Waveform	Pure sine wave: <=2% THD (linear load), <=4% THD (non-linear load)	
	Frequency	50/60Hz +/-0.1Hz	
	Efficiency	Up to 98%	
	Overload capacity	> 110% & ≤ 130% for 5 min; > 130% & ≤140% for 30 sec; >140% for 1.5 sec	
BATTERY	Battery chemistry	Sealed, maintenance-free lead acid	
	Battery size	(3) 12V 9AH	(4) 12V 9AH
	Typical recharge / charger	< 3 hours to 95% with 2A charger current	
	Charger current	2A default, Max 8A Adjustable	
PHYSICAL	Charger voltage	41.1VDC	54.8VDC
	Dimensions (W x D x H, in)	17.2 x 15.1 x 3.5***	17.2 x 19 x 3.5***
	Weight (lbs)	34.2	43
	Line cord	C14 inlet, 8 ft (2.4 m)L6-20P to C13 line cord	C20 inlet, 8 ft (2.4 m)L6-20P to C19 line cord
ENVIRONMENT	Receptacles	(8) C13	
	Temperature	32–104°F (0 ~ 40°C)	
	Altitude	11,500 ft above sea level	
APPROVALS	CE, RoHS		
WARRANTY	3 years electronics, 3 years battery warranty (USA and Canada)		
COMMUNICATION INTERFACE	RS-232 (2U), USB, EPO, intelligent slot for optional cards (Web/SNMP, Relay/dry contact,		
INCLUDED IN BOX	ViewPower software, horizontal brackets, tower pedestals, user manual		
AVAILABLE OPTIONS	Bypass distribution (XBDM), power distribution (XPDU), 4-post rail kit, 2-post shelf kit, wall mount bracket		

*Depending on load level

Output Power Rating Table (P91 models)

Model name	Input rating	Output rating
P91-1000	100-125Vac, 50/60Hz, 12A, 1Ø	100/110/115/120/125Vac, 50/60Hz, 1000VA/1000W, 1Ø, 10/9.1/8.7/8.3/8A
P91-1500	100-125Vac, 50/60Hz, 12A, 1Ø	100/110/115/120/125Vac, 50/60Hz, 1Ø 1500VA/1430W,12A (@125Vac input) ; 1500VA/1300W,12.5A (@120Vac input) ; 1500VA/1270W,13A (@115Vac input) ; 1500VA/1200W,13.6A (@110Vac input) ; 1350VA/1040W,13.5A (@100Vac input)
P91-2000	100-125Vac, 50/60Hz, 16A, 1Ø	100/110/115/120/125Vac, 50/60Hz, 1Ø 2000VA/1930W,16A (@125Vac input) ; 2000VA/1850W,16.7A (@120Vac input) ; 2000VA/1740W,17.4A (@115Vac input) ; 2000VA/1640W,18.2A (@110Vac input) ; 1800VA/1500W,18A (@100Vac input)
P91-3000	100-125Vac, 50/60Hz, 24A, 1Ø	100/110/115/120/125Vac, 50/60Hz, 1Ø 3000VA/2850W,24A (@125Vac input) ; 3000VA/2740W,25A (@120Vac input) ; 3000VA/2650W,26.1A (@115Vac input) ; 3000VA/2500W,27.3A (@110Vac input) ; 2700VA/2300W,27A (@100Vac input)

Runtime Chart (internal battery)

Model	P91-1000	P91-1500	P91-2000	P91-3000
Battery Load percentage	(9Ah x 2)	(9Ah x 3)	(9Ah x 4)	(9Ah x 6)
100.00%	2.43	2.57	2.43	2.64
90.00%	3.19	3.36	3.19	3.36
80.00%	4.14	4.34	4.06	4.34
70.00%	5.31	5.42	5.31	5.53
60.00%	6.93	6.93	7.06	7.33
50.00%	9.44	9.46	9.56	9.79
40.00%	12.92	12.89	13.20	13.51
30.00%	18.52	18.43	19.12	19.90
20.00%	29.90	29.44	31.06	32.61
10.00%	63.67	61.16	68.38	72.53

Battery Pack Specification

Model	P90-BP36	P90-BP36E	P90-BP48	P90-BP72
Used with UPS Models	P91-1500/P91g-1500		P91-2000/P91g-2000	P91-3000/P91g-3000
Battery Type	12V 9Ah	12V 9Ah	12V 9Ah	12V 9Ah
Battery Numbers	6	12	8	12
Dimensions (WxDxH)	17.2 x 18.9 x 3.5 in	17.2 x 23.6 x 3.5 in	17.2 x 18.9 x 3.5 in	17.2 x 23.6 x 3.5 in
Net Weight	58.1 lbs	104.4 lbs	74.6 lbs	104.4 lbs

NOTE: Battery pack should be used with corresponding UPS.

7. Obtaining Service

If the UPS requires Service:

1. Use the TROUBLESHOOTING section in this manual to eliminate obvious causes.
2. Verify there are no circuit breakers tripped.
3. Call your dealer for assistance. If you cannot reach your dealer, or if they cannot resolve the problem, call Xtreme Power Conversion Corp Technical Support at 800.582.4524. Technical support inquiries can also be made at support@xpcc.com. Please have the following information available BEFORE calling the Technical Support Department:
 - Your name and address.
 - The serial number of the unit.
 - Where and when the unit was purchased.
 - All of the model information about your UPS.
 - Any information on the failure, including LED's that may or may not be illuminated.
 - A description of the protected equipment, including model numbers if possible.
 - A technician will ask you for the above information and, if possible, help solve your problem over the phone. In the event that the unit requires factory service, the technician will issue you a Return Material Authorization number (RMA).

If you are returning the UPS to Xtreme Power for service, please follow these procedures:

1. Pack the UPS in its original packaging. If the original packaging is no longer available, ask the Technical Support Technician about obtaining a replacement set of packaging material. It is important to pack the UPS properly in order to avoid damage in transit. Never use Styrofoam beads for a packing material.
2. Include a letter with your name, address, daytime phone number, RMA number, a copy of your original sales receipt, and a brief description of the problem.
3. Mark the RMA number on the outside of all packages. Xtreme Power cannot accept any package without the RMA number marked on the outside of the boxes.
4. Return the UPS by insured, prepaid carrier to the address provided by the Technician.
5. Refer to the Warranty statements in this manual for additional details on what is covered.

8. Xtreme Power Conversion Limited Warranty

Xtreme Power Conversion (XPC) Corporation warrants Xtreme Power Conversion equipment, when properly applied and operated within specified conditions, against faulty materials or workmanship for a period of **three years for P91-Series products** from the date of purchase. XPC Corporation warrants **internal batteries for a period of three years** from the date of purchase. For equipment sites within the United States and Canada, this warranty covers repair or replacement, at the sole discretion of XPC Corporation. The customer is responsible for the costs of shipping the defective product to XPC Corporation. XPC Corporation will pay for ground shipment of the repaired or replacement product. This warranty applies only to the original purchaser.

If equipment provided by XPC Corporation is found to be **Dead-on-Arrival (DOA)**, XPC Corporation will be responsible for the costs of shipping product to and returning equipment from the customer in a timely manner as agreed to with the customer, once the customer has requested and received a **Return Material Authorization (RMA)** number. DOA equipment is defined as equipment that does not properly function according to user documentation when initially received and connected in conjunction with proper procedures as shown in the user documentation or via support provided by XPC Corporation personnel or authorized agents.

This warranty shall be void if (a) the equipment is repaired or modified by anyone other than XPC Corporation or a XPC Corporation approved third party; (b) the equipment is damaged by the customer, is improperly used or stored, is subjected to an adverse operating environment, or is operated outside the limits of its electrical specifications; or (c) the equipment has been used or stored in a manner contrary to the equipment's operating manual, intended use or other written instructions. Any technical advice furnished by XPC Corporation or a XPC Corporation authorized representative before or after delivery with regard to the use or application of Xtreme Power Conversion equipment is furnished on the basis that it represents XPC Corporations best judgment under the situation and circumstances, but it is used at the recipient's sole risk.

EXCEPT AS STATED ABOVE, XPC Corporation DISCLAIMS ALL WARRANTIES, EXPRESSED OR IMPLIED, INCLUDING WARRANTIES OF MERCHANTABILITY AND FITNESS FOR A PARTICULAR PURPOSE.

EXCEPT AS STATED ABOVE, IN NO EVENT WILL XPC Corporation BE LIABLE FOR DIRECT, INDIRECT, SPECIAL, INCIDENTAL, OR CONSEQUENTIAL DAMAGES ARISING OUT OF THE USE OF Xtreme Power Conversion EQUIPMENT, including but not limited to, any costs, lost profits or revenue, loss of equipment, loss of use of equipment, loss of software, loss of data, cost of substitutes, or claims by third parties. Purchaser's sole and exclusive remedy for breach of any warranty, expressed or implied, concerning Xtreme Power Conversion equipment, and the only obligation of XPC Corporation under this warranty, shall be the repair or replacement of defective equipment, components, or parts; or, at XPC Corporations sole discretion, refund of the purchase price or substitution of an equivalent replacement product.

9. Xtreme Power Conversion Load Protection Policy

THIS POLICY IS NOT A WARRANTY. REFER TO **THE XPC CORPORATION, INC. LIMITED WARRANTY** FOR INFORMATION CONCERNING THE WARRANTY FOR YOUR XPC PRODUCT. THE LIMITATIONS AND CONDITIONS CONTAINED IN THIS POLICY DO NOT AFFECT **THE TERMS OF THE XPC LIMITED WARRANTY**.

Definitions:

1. "Product" means a Standard 120, 208, or 240 Volt power protection device that is used in the United States and Canada. This policy does not include custom manufactured products.
2. "Power Disturbance" means an AC power line transient (telephone line or Local Area Network, if applicable), spike or surge.
3. "Connected Equipment" properly connected electronic equipment
4. "Fair Market Value" of damaged Connected Equipment as determined by XPC shall be the lower of (a) the average price the same or similar items are being sold for on eBay, (b) the price list of Orion Blue Book (or if such price list is no longer published, a published or announced price list reasonably selected by XPC), (c) the lowest price the same or similar items can be purchased for in the United States or (d) the total amount of all payment(s) you have or are entitled to receive from insurance, other warranties, extended warranties, a legal liability claim or from other sources or persons for the damaged Connected Equipment.
5. "Purchaser" means the person or entity that originally purchased the Product from an authorized reseller or distributor of XPC Products.

The Purchaser of this Product is protected, for the term of the XPC Limited Warranty, against certain losses caused by a Power Disturbance for properly connected electronic equipment (referred to as the "Connected Equipment") subject to certain terms and conditions provided below.

This policy applies only to the original purchaser of the Product. If the Product is transferred or sold to another person or entity, this policy is void.

Load Protection Policy Dollar and Period Limits

For purchasers that meet the qualifications and conditions set forth in this policy, XPC will provide reimbursement (cost of repair or fair market value as determined by XPC) during the period limits and up to the dollar limits stated as follows:

PRODUCT	DOLLAR LIMIT	PERIOD OF COVERAGE
A60	25,000	Term of XPC Limited Warranty
XST	25,000	Term of XPC Limited Warranty
S70	25,000	Term of XPC Limited Warranty
M90S	50,000	Term of XPC Limited Warranty
P91 5, 6 & 10kVA	50,000	Term of XPC Limited Warranty
P80/P80g	50,000	Term of XPC Limited Warranty

P90, P90L, P90g, P90Lg, P91	50,000	Term of XPC Limited Warranty
T91	50,000	Term of XPC Limited Warranty
TX91, TX91L	50,000	Term of XPC Limited Warranty

This Load Protection Policy is not deemed "first dollar" coverage. XPC's obligation is reduced by any amounts that the Purchaser is entitled to recover, from other sources regarding the Connected Equipment, including, but not limited to, insurance, other warranty, extended warranty, or legal liability, regardless of whether or not the Purchaser makes a claim for recovery.

Eligibility for Coverage Under the Load Protection Policy

1. The Product must be registered on the XPC website, www.xpcc.com, within 10 days of purchase. All required information must be provided, and Purchaser should retain a copy for Purchaser's records. When registering on the website, Purchaser must list all connected equipment that is directly connected to the product. Only those devices registered in that manner will be covered.
2. All Connected Equipment must be UL or CSA approved.
3. The Product must be plugged into a properly wired and grounded outlet. Use of input surge devices, extension cords, adapters, ground wires, or electrical connections not manufactured by XPC voids the XPC Load Protection Policy. No other surge protection device may be connected to the output sockets of the Product. The installation must comply with all applicable electrical and safety codes set forth pursuant to the NEC.
4. The Product must have undeniable physical evidence of a Power Disturbance that directly and proximately caused the damage;
5. The Connected Equipment must have been damaged by a Power Disturbance on a properly installed, grounded, and National Electric Code, ("NEC"), code-compliant 120, 208, 240 Volt AC power line in the United States or Canada, by a Power Disturbance on standard telephone land line or PBX telephone equipment line that is properly installed and connected to an RJ11 port on the Product; or by a Power Disturbance on a standard Local Area Network connection that is properly installed and connected to an RJ45 port on the Product and (d) is directly plugged into, and properly connected to, the Product in its original condition which was properly operated when a Power Disturbance passed through the Product and (i) exhausts the protection capacity of the Product or (ii) damages the Product.
6. The Load Protection Policy does not apply if the Product has been operated in a failure mode or not in compliance with XPC operating instructions in the Product user's manual, or if the Connected Equipment has not been operated in compliance with the instructions and manuals of its manufacturer/vendor.
7. This policy is null and void if, XPC determines, in its sole discretion, that the Product has been tampered with or altered in any way.

What is Not Covered Under the Load Protection Policy:

The following damage is not covered by this Policy:

1. Restoration of lost data and reinstallation of software.
2. Damage from a cause other than AC power-line transients, except for damage due to telephone line, Local Area Network, or CATV transients, which is covered only if the Product offers such protection.
3. DAMAGE CAUSED BY FAILURE TO PROVIDE A SUITABLE INSTALLATION ENVIRONMENT FOR THE PRODUCT (INCLUDING, BUT NOT LIMITED TO, LACK OF A PROPER SAFETY GROUND).
4. Damage caused by the use of the Product for purposes other than those for which it was designed.
5. Damage caused by accidents, or natural disasters, including but not limited to, fire, flood, and wind.
6. Damage caused by abuse, misuse, alteration, modification, or negligence.
7. Any labor costs or travel, room and board expenses associated with the repair and/or restoration of lost or damaged hardware, software or data.

EXCEPT AS EXPRESSLY PROVIDED IN THIS POLICY, XPC SHALL NOT BE LIABLE FOR ANY DAMAGES WHATSOEVER, INCLUDING, BUT NOT LIMITED TO, DIRECT, INDIRECT, SPECIAL, INCIDENTAL, CONSEQUENTIAL, OR MULTIPLE DAMAGES ARISING OUT OF THE USE OF THE PRODUCT OR DAMAGE TO THE CONNECTED EQUIPMENT, REGARDLESS OF THE LEGAL THEORY ON WHICH SUCH CLAIM IS BASED, EVEN IF ADVISED OF THE POSSIBILITY OF SUCH DAMAGE. SUCH DAMAGES INCLUDE, BUT ARE NOT LIMITED TO, LOSS OF PROFITS, LOSS OF SAVINGS OR REVENUE, LOSS OF USE OF THE PRODUCT OR THE CONNECTED EQUIPMENT OR ANY ASSOCIATED EQUIPMENT, LOSS OF SOFTWARE, COST OF CAPITAL, COST OF ANY SUBSTITUTE EQUIPMENT, FACILITIES OR SERVICES, DOWNTIME, THE CLAIMS OF THIRD PARTIES, INCLUDING CUSTOMERS, AND INJURY TO PROPERTY.

Submitting a Load Protection Policy Claim:

1. Any claim under the Load Protection Policy must be made within 10 days of the date of alleged damage to the Connected Equipment.
2. Call the XPC technical support department at 1-800- 582-4524 and obtain a Load Protection Policy Returned Material Authorization (RMA) number. Have information on all applicable insurance or other resources of recovery/payment that is available to the Purchaser and the name of the power utility supplier for the location of the Connected Equipment. XPC will forward to the Purchaser a Load Protection Policy claims form, which must be completed and filed with XPC within 30 days.
 - Mark the Load Protection Policy RMA number on the Product the Purchaser is returning.
 - Pack the Product in its original packaging or similar packing materials if the original packaging has been discarded. Enclose the completed Load Protection Policy claim form and a copy of the Purchaser's original sales receipt for the Product in the box.
 - Mark the RMA number clearly on the outside of the box.
 - Ship the Product (one-way shipping charges paid by the Purchaser) to:

XPC Corporation
230 Yuma Street
Denver, CO 80223
Attn: LPP RMA#

3. XPC will evaluate the Product to determine its level of functionality, and will examine the Product for evidence of damage from a Power Disturbance.
- If XPCs' evaluation provides no evidence of damage from a Power Disturbance, XPC will send to the Purchaser (i) a report summarizing the tests performed and (ii) a rejection of claim notice.
 - If the Product shows evidence of damage from a Power Disturbance, XPC will request that all Connected Equipment for which a Load Protection Policy claim has been submitted, be sent for evaluation to either XPC or an authorized service center. If it is determined that the Connected Equipment has been damaged by a Power Disturbance, XPC will, in its sole discretion, issue payment to the Purchaser for either the cost of repair of the Connected Equipment or the Fair Market Value of the damaged Connected Equipment, up to the dollar limits stated above. XPC reserves the right to require the Purchaser to transfer title and deliver the Connected Equipment to XPC if it chooses to reimburse the Purchaser for the fair market value of the Connected Equipment. XPCs' maximum liability shall be reduced to reflect all such other payments or sources of recovery, whether applied for or not.
4. If XPC issues payment to the Purchaser to have the Connected Equipment repaired, the repair must be performed at a service center that is authorized by the manufacturer of the Connected Equipment. XPC reserves the right to contact the authorized service center directly to discuss repair costs and damage to the Connected Equipment to determine if it was caused by a Power Disturbance and the right to request that the service center forward the Connected Equipment or components of the Connected Equipment to XPC for inspection
5. Unless modified in writing signed by an officer of XPC and the Purchaser, the terms of this policy are the complete and exclusive agreement between the parties, superseding all prior agreements, oral or written, and all other communications between the parties relating to the subject matter of this agreement. No employee of XPC or any other party is authorized to make any representations beyond those made in this agreement concerning the Load Protection Policy.

XPC Corporation
230 Yuma Street
Denver, CO 80223
1.800.582.4524